



Ground

Porcelain tile

peronda



Ground

The largest format with the latest technology

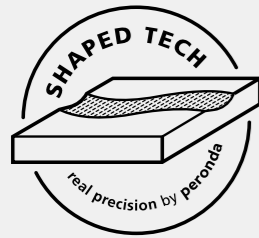

Peronda presenta su última innovación en dimensiones de la pieza, donde aúna cantidad pero también calidad. El gran formato 100x260 cm, si bien ya conocido en el mundo de la cerámica, resurge en esta ocasión de la mano de Peronda para ofrecer por primera vez la mejor opción estética gracias a su acabado Shaped, el más realista del mercado. Shaped combina relieve y gráfica en cada pieza para replicar la naturaleza con precisión, pues se trata de la última tecnología de impresión en bajorrelieve. 100x260 cm Shaped, formatos mayúsculos para espacios monumentales.

Peronda presents its latest innovation regarding tile size by matching not only quantity but quality. The large 100x260 cm format, which is known within the ceramics field, makes a comeback by Peronda's hand to offer the most beautiful option for the first time thanks to its Shaped finish, the most realistic on the market. Shaped combines relief and graphics on each tile to replicate nature accurately, for it is the latest in bas-relief printing technology. 100 x 260 cm Shaped, capital formats for monumental spaces.

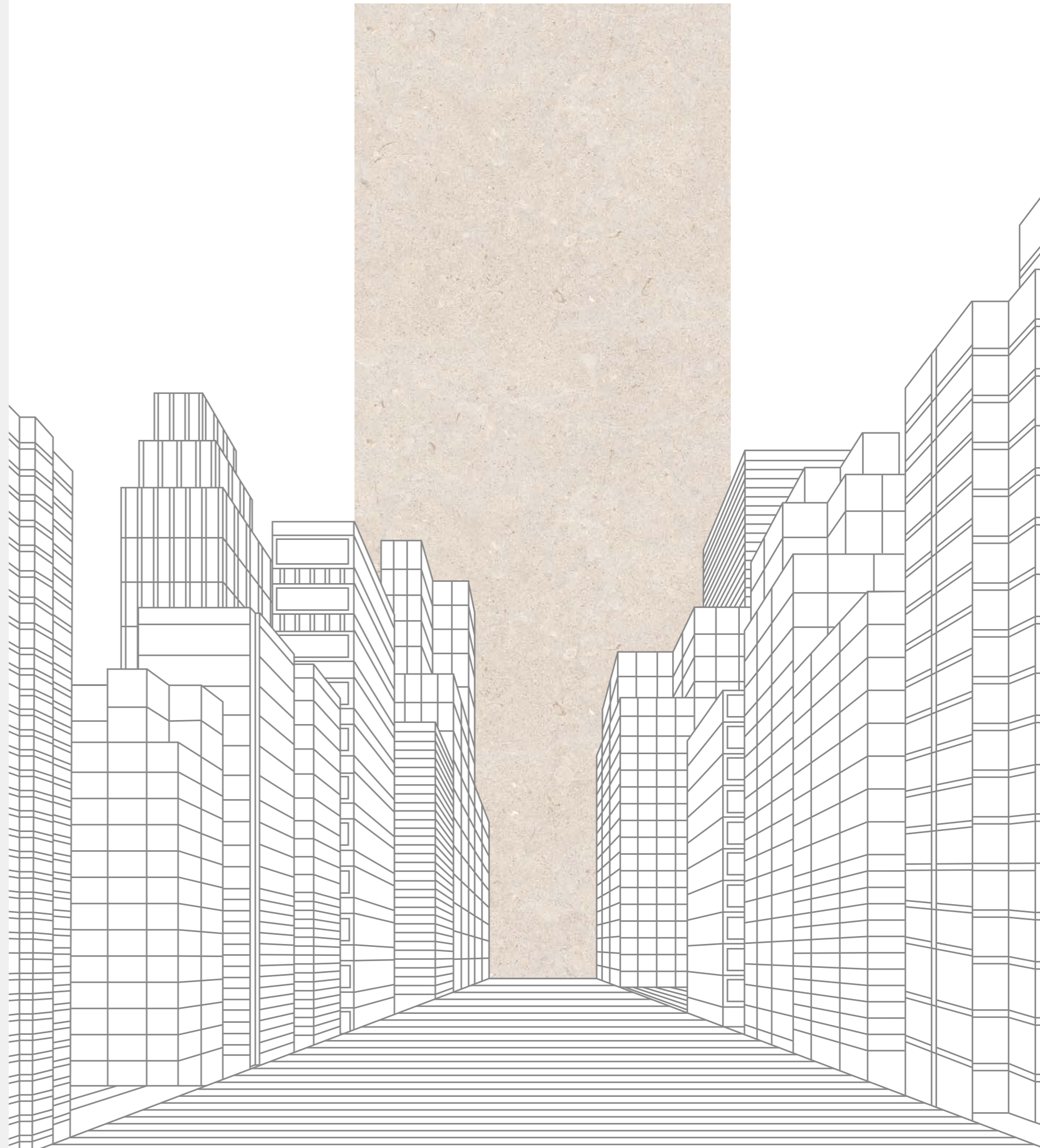

Ground

Shaped 4D

100x100

100x260



BONE



SILVER



GREY



GROUND 100x260 Grey Shaped



GROUND 100x100 Grey Shaped





GROUND 100x260 Grey Shaped





GROUND

Shaped 4D

GROUND 100x260 Grey Shaped



GROUND 100x260 Silver Shaped





GROUND

Shaped 4D

GROUND 100x260 BONE Shaped



Ground

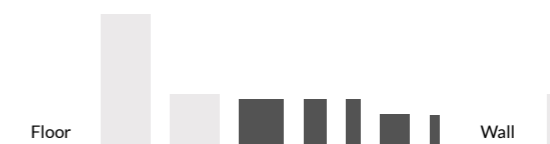
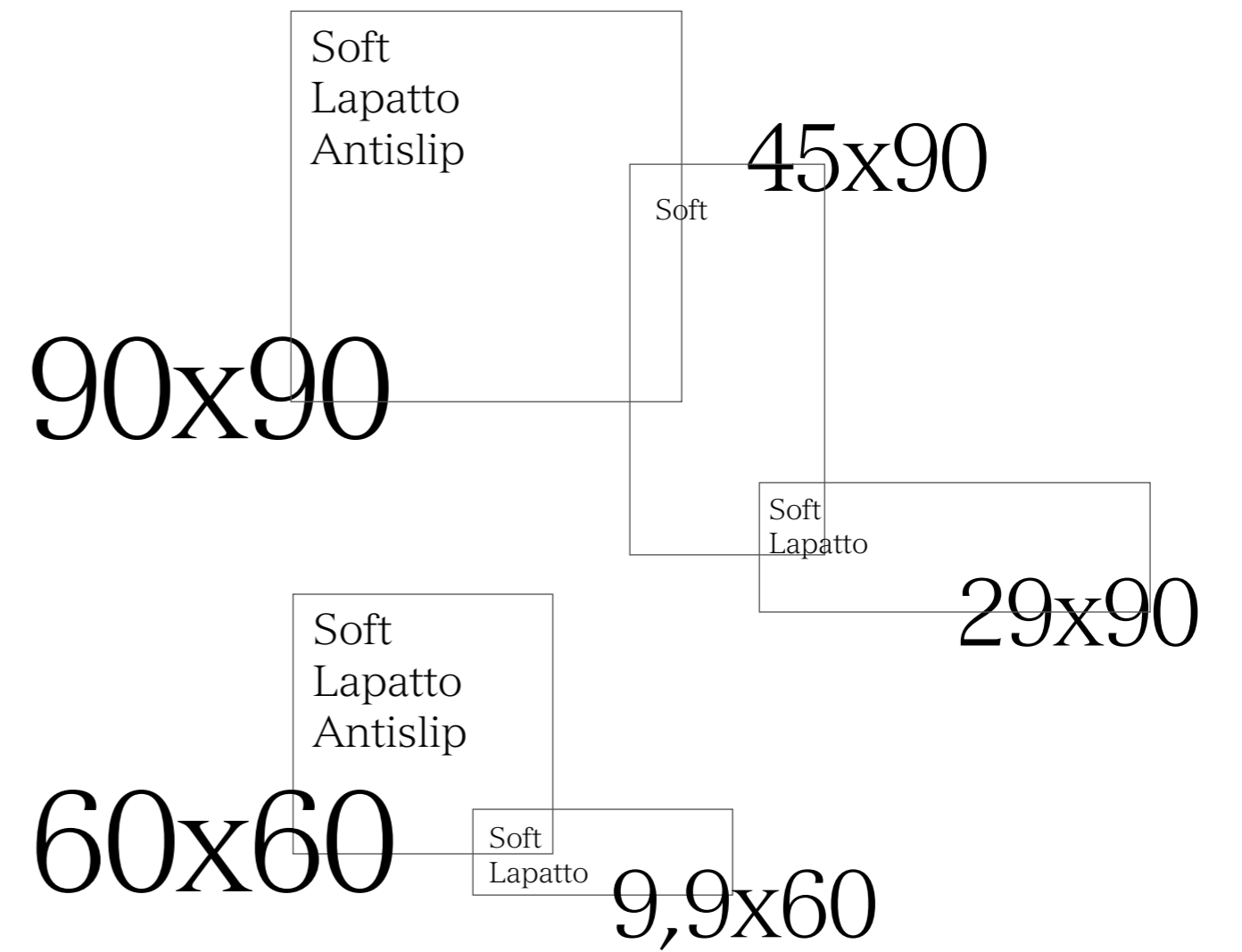



18

GROUND 45x90 Grey Soft



GROUND 90x90 Grey Antislip





GROUND 90x90 Bone Soft



GROUND 90x90 Bone Antislip





GROUND 90x90 Grey Soft



GROUND 90x90 Grey Soft



GROUND 90x90 Grey Soft



Ground



Shaped 4D

33,3x100

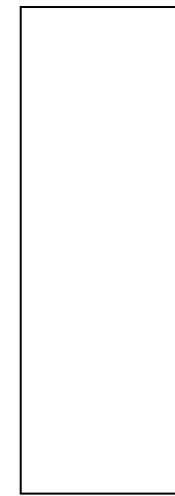



GROUND 33,3x100 Bone Shaped

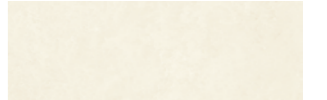

GROUND 33,3x100 Decor Bone Shaped



GROUND 100x100 Bone Shaped





GROUND 33,3x100 Silver Shaped

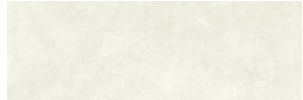

GROUND 33,3x100 Decor Silver Shaped



VERBIER 24x151 Taupe All in one



GROUND porcelain

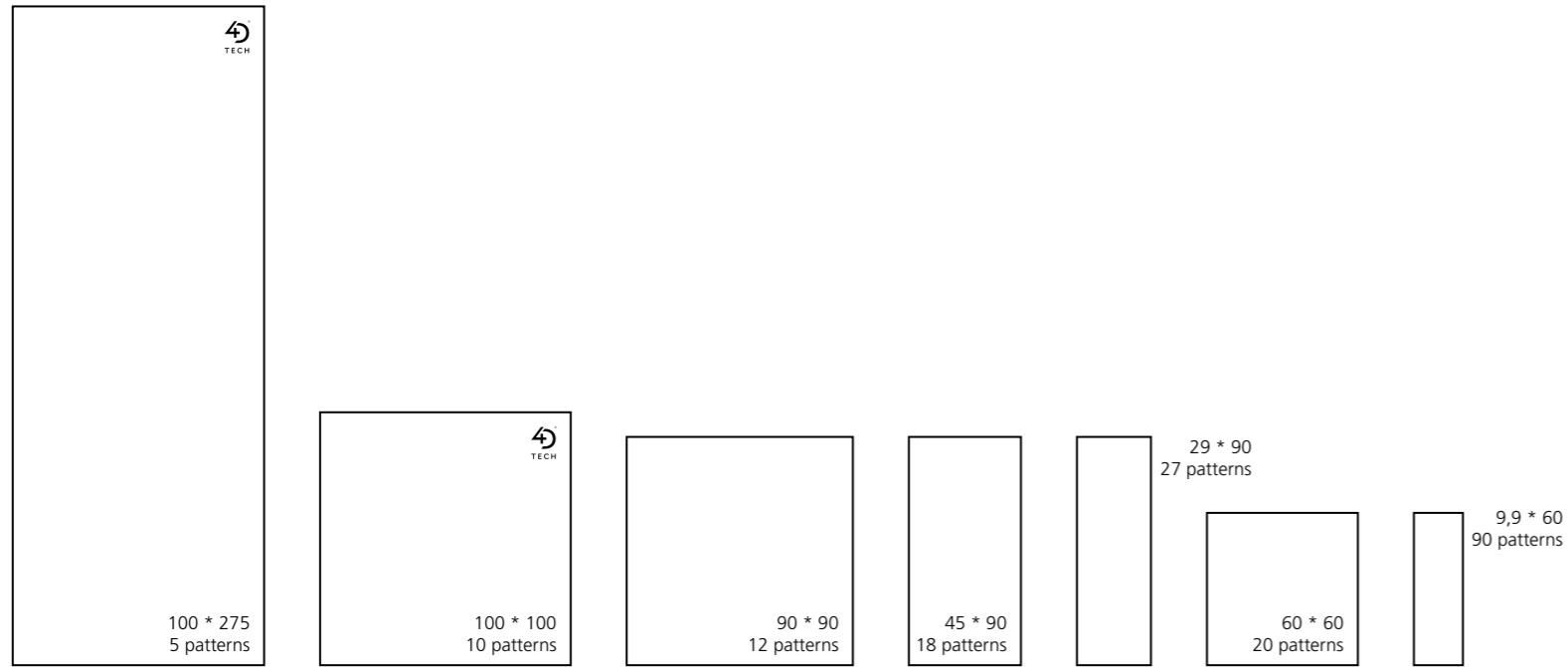

	100*275*0,6 cm 39*108"	100*100*0,6 cm 39*39"	90*90*1 cm 36*36"			45*90*1 cm 18*36"	29*90*1 cm 12*36"		60*60*1 cm 24*24"			9,9*60*1 cm 4*24"		
	RECTIFIED	SHAPED	SHAPED	SOFT	LAPATTO	ANTISLIP	SOFT	SOFT	LAPATTO	SOFT	LAPATTO	ANTISLIP	SOFT	LAPATTO
	BN141	BN135	BN48	BN42	BN90	BN70	BN114	BN115	BN33	BN38	BN88	BN97	BN98	
BONE	33123	32889	24944	27134	24973	24930	24920	27119	24936	27128	24979	24941	27131	
GREY	33125	32890	24792	27135	24974	24931	24921	27120	24937	27130	24980	24942	27133	
SILVER	33124	32888	24790	27136	24975	24932	24922	27121	24938	27129	24981	24943	27132	



GROUND white body



	33,3*100*0,75 cm 13*39"	33,3*100*0,86 cm 13*39"
	RECTIFIED	NATURAL
	BN65	DECOR_NATURAL
	BN66	
BONE	34761	34813
SILVER	34762	34815
WHITE	34763	34814



Porcelain

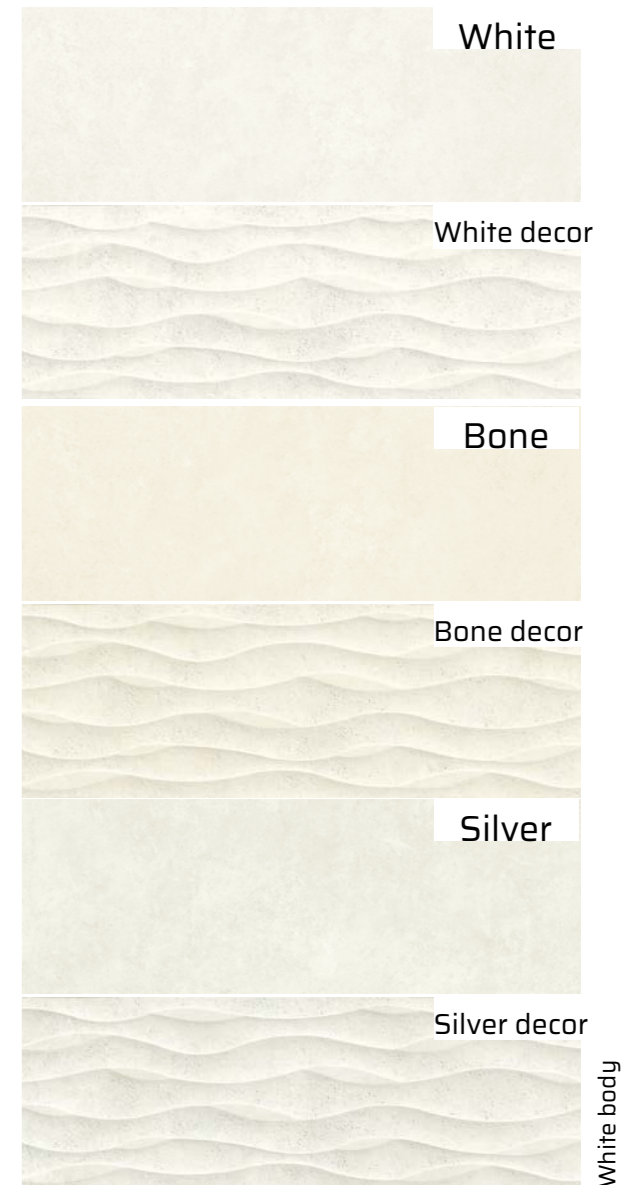

White body

PIEZAS ESPECIALES | SPECIAL PIECES

D. GROUND MOSAIC		D. GROUND SPAC		MILA			D. MILA MOSAIC	
30*30*1 cm 12*12"	30*30*1 cm 12*12"	60*60*1 cm 24*24"			30*30*1 cm 12*12"			
RECT.	SOFT	SOFT	RECT.	SOFT	LAPATTO	MOSAIC		
	P37	P58		BN40	BN83	SOFT		
BONE	23435	23505				P37		
GREY	23438	23506	WARM	24953	27137	23441		
SILVER	23439	23507	COLD	24952	27138	23442		

CARACTERÍSTICAS TÉCNICAS | TECHNICAL CHARACTERISTICS

joint	frost proof	versatile	matt	full body	diferent shades	shade variation	various graphics

ANTIDESLIZAMIENTO | ANTI-SLIP

FINISHED	DIN 51130	DIN 51097	BS 7976-2 (PTV)	UNE 41901 EX	ANSI A137.1 (DCOF)	ISO 10545-6
SHAPED	-	-	-	Class 1	> 0,42	< 175 mm ³
ALL IN ONE	R11	A+B+C	+36 Wet	Class 3	> 0,42	< 175 mm ³
ANTISLIP	R11	A+B+C	+36 Wet	Class 3	> 0,42	< 175 mm ³
NATURAL	R10	A+B	+36 Wet	Class 2	> 0,42	< 175 mm ³

CARACTERÍSTICAS TÉCNICAS | TECHNICAL CHARACTERISTICS

joint	wall tiles	matt	diferent shades	shade variation	various graphics

TECHNICAL INFORMATION

PIEZA COMPLEMENTARIA | COMPLEMENTARY PIECE

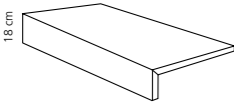
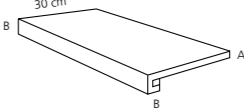
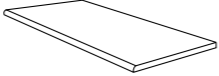
PL. /18 Peldaño técnico - Technical stair - thread	PT. Peldaño técnico - Technical stair - thread	PR. Peldaño Romo Rounded stair - thread
		
30*100 cm 12*39" P74	30*100 cm 12*39" P74 A = 0,6 cm B = 1,8 cm A = 0,8 cm B = 2,4 cm	30*100 cm 12*39" P85
30*90 cm 12*36" P76 30*60 cm 12*24" P54 30*120 cm 12*48" P75	30*90 cm 12*36" P76 30*60 cm 12*24" P54 30*120 cm 12*48" P75 A = 1 cm B = 3 cm	30*90 cm 12*36" P61 30*60 cm 12*24" P64 30*120 cm 12*48" P77

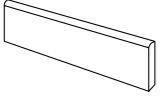
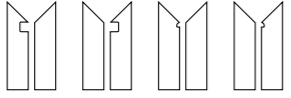
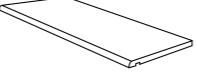

Accede al código QR y visualiza el manual técnico de colocación de gran formato. Enter with the QR code and view the technical manual for laying slabs.

R. Rodapie Skirting	S.K.I.	S.K.D.	Z.R.I.	Z.R.D.	AF. Alféizar - Windowsill
					
8*100 cm 3*39" P45 8*90 cm 3*36" P44 8*60 cm 3*24" P34	8*30 cm 3*12" P53 8*30 cm 3*12" P55				25*90 cm 10*36" P77 25*120 cm 10*48" P54

PIEZA ESPECIAL PISCINA | SPECIAL PIECE POOL

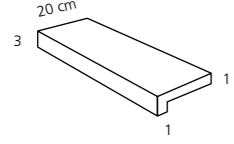
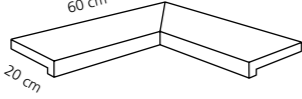
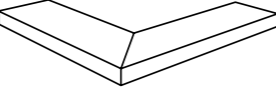
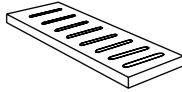
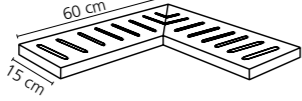
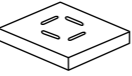
P.V. Peldaño Vierteagua Pool Coping	ANG.P.V. Peldaño vierteagua angulo Pool Coping internal corner	E.P.V. Peldaño vierteagua esquina Pool Coping external corner
		
20*60 cm 8*24" P61 20*90 cm 8*36" P81	20*60 cm 8*24" P70 (PACK 2 units) 20*90 cm 8*36" P75 (PACK 2 units)	20*60 cm 8*24" P70 (PACK 2 units) 20*90 cm 8*36" P75 (PACK 2 units)
REJ. Rejilla Drainage grate	ANG.REJ. Angulo rejilla Angle corner drainage grate	T.REJ. Taco rejilla Square corner drainage grate
		
15*60*2,2 cm 6*24" P54 15*90*2,2 cm 6*36" P76	15*60*2,2 cm 6*24" P75 (PACK 2 units) 15*90*2,2 cm 6*36" P57 (PACK 2 units)	15*15*2,2 cm 6*6" P85

EMBALAJE PLACA | SLAB PACKING

(Los pesos aquí reflejados pueden sufrir ligeras variaciones en función del lote de producción. Weights shown here may slightly vary depending on the production lot.)

Formato Sizes	Placa Slab			Cajón madera Wooden crate				Cont./20' 21500-24000 kg. (24 cajones crates)		
	cm	Piezas	m ² / sq.m	kg	placas	m ² / sq.m	kg	Tamaño cm aprox.	m ² / sq.m	Kg
100 * 260 * 0,6	1	2,6	36,40	20	52	826,8		112 * 278 * 31	1248	19843,2
inch	units	ft ²	lb	Slabs	ft ²	lb		Sizes Inch approx.	ft ²	lb
39 3/8 * 102 3/8 * 1/4	1	28	80,24	20	559,7	1822,8		44 1/8 * 109 7/16 * 12 3/16	13433,4	43746,8

EMBALAJE | PACKING

	Formato Sizes	Cajas Boxes			Pallet (P)			Cont./20' 21500 kg.	Cont./20' 24000 kg.		
	cm	Piezas	m ²	kg	Cajas	m ²	kg	Tamaño aprox. cm	m ²	m ²	
Porcelain	100 * 100 * 0,6	2	2	27,8	24	48	709,2	112 * 112 * 61	1440 m ² (30 P)	21276 kg (30 P)	
	90 * 90 * 1	2	1,62	37,96	22	35,64	860	105 * 95 * 75	891	994	
	60 * 120 * 1	2	1,44	33,18	27	38,88	920	120 * 80 * 75	908,61	1014,26	
	60 * 60 * 1	3	1,08	24,3	40	43,2	996	120 * 80 * 75	933	1041	
	45 * 90 * 1	2	0,81	19,08	36	29,16	699	100 * 100 * 59	896,91	1001,2	
	29 * 90 * 1	3	0,78	20	54	42,12	1105	105 * 95 * 75	819,53	914,82	
White body wall tile	9,9 * 60 * 1	13	0,77	16,45	64	49,28	1065	100 * 100 * 94	994,85	1110,54	
	33,3 * 100 * 0,75	6	2	26,60	24	48	663	118 * 110 * 48	1556,56	1737,56	
	33,3 * 100 * 0,86	5	1,67	24	24	40,08	601	118 * 110 * 48	1544,30	1723,87	
	inch	units	ft ²	lb	Boxes	ft ²	lb	Sizes Inch approx.	ft ²	ft ²	
	Porcelain	39 3/8 * 39 3/8 * 1/4	2	21,52	61,29	24	516,66	1563,51	44 1/8 * 44 1/8 * 24	15500 ft ² (30 P)	46905,55 lb (30 P)
		35 7/16 * 35 7/16 * 3/8	2	17,44	83,69	22	383,63	1896	41 5/6 * 37 3/8 * 29 1/2	9590,64	10699,3
	23 5/8 * 47 1/4 * 3/8	2	15,50	73,15	27	418,50	2027,92	47 1/4 * 31 1/2 * 29 1/2	9781,75	10919,17	
	23 5/8 * 23 5/8 * 3/8	3	11,63	53,57	40	465	2.195,8	47 1/4 * 31 1/2 * 29 1/2	10042,7	11205,23	
	17 11/16 * 35 7/16 * 3/8	2	8,72	42,07	36	313,88	1541,3	41 5/16 * 31 1/2 * 41 5/16	9654,34	10776,94	
	11 7/16 * 35 7/16 * 3/8	3	8,4	44,09	54	453,38	2436,53	41 5/16 * 37 3/8 * 29 1/2	8821,41	9847,16	
	3 7/8 * 23 5/8 * 3/8	13	8,29	36,27	64	530,45	2348,33	39 3/8 * 39 3/8 * 37	10708,61	11953,8	
White body wall tile	13 1/8 * 39 3/8 * 1/4	6	21,53	58,65	24	516,67	1461,92	46 7/16 * 43 5/16 * 18 7/8	16754,82	18703,06	
	13 1/8 * 39 3/8 * 5/16	5	17,98	48,95	24	431,42	1230,39	46 7/16 * 43 5/16 * 18 7/8	16622,86	18555,75	

Debido a los procesos de impresión, los colores que aparecen en este catálogo deben considerarse aproximados, y no exactos. Los derechos de todos los contenidos (textos, fotografías, dibujos, diseños etc) del presente catálogo son propiedad de PERONDA GROUP.S.A (o en su defecto, cuentan con los correspondientes permisos y autorizaciones de sus titulares). No está permitida la reproducción total o parcial de esta publicación, ni su tratamiento informático, ni la transmisión de ninguna forma o por cualquier medio, ya sea electrónico, mecánico, por fotocopia, por registro u otros medios, sin el permiso previo y por escrito de los titulares del copyright.

All colours and hues appearing in this catalogue should be considered approximate, only in view of the printing processes involved. The rights of all contents (texts, photographs, drawings, designs, etc.) of this catalogue remain the property of PERONDA GROUP.S.A (or, failing that, they have the corresponding permissions and authorizations of the owners). No part of this publication may be reproduced, stored in a retrieval system, or transmitted in any form or by any means, electronic, mechanical, photocopying, recording or otherwise, without the prior written permission of the copyright holders.

PERONDA GROUP 2022 | Av. Manuel Escobedo, 26. | 12200 Onda (Castellón) España

peronda

peronda.com

Av. Manuel Escobedo, 26 _ P.O Box 51
12200 **Onda (Castellón)** España
964 602 012 _ f. 964 600 361 _ f. exportación (+34) 964 771 162